

Auxiliary hand levers for solenoid valves

direct operated on-off and proportional, ISO 4401 size 06

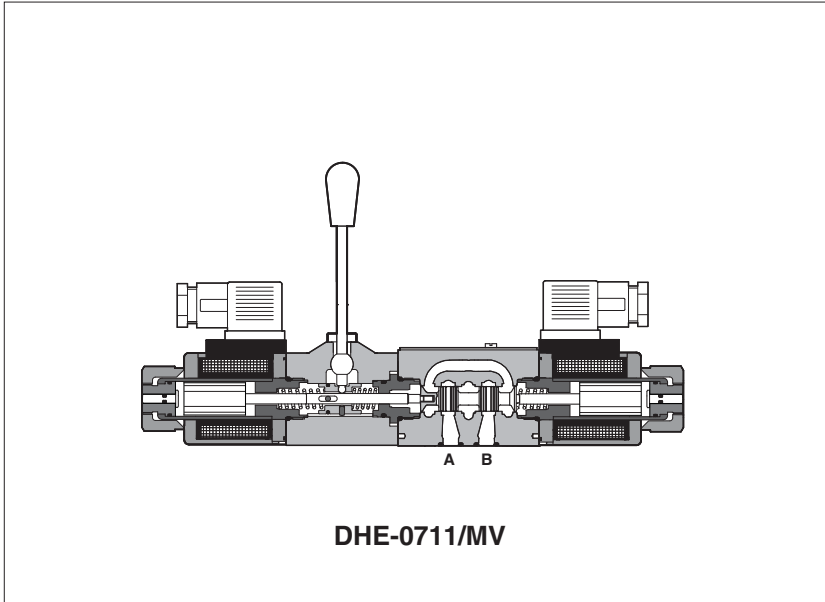

Auxiliary hand levers for direct operated on-off solenoid valves size 06, type DHI, DHE, DHA and proportional valves size 06, type DHZO, DHZE, DHZA and QVHZO.

This option allows to operate the valves in absence of electrical power supply, i.e. during commissioning, maintenance or in case of emergency.

It is available with two different configurations depending to the installation requirements:

- MV** = lever positioned vertically (perpendicular to the valve axis)
- MO** = lever positioned horizontally (parallel to the valve axis)

When the valve is electrically operated the hand lever remains stopped in its rest position

The hand lever execution does not affect the performances of the original valves.

1 MODEL CODE FOR ON-OFF DIRECTIONAL VALVES (for the details, see indicated tech. table)

DHE - 0	63	1/2	/	MV	-	X	24 DC	**	/*
Directional control valves size 06 DHI-0= for AC and DC supply, with cURus certified solenoids - see table E010 DHE-0= for AC and DC supply, high performances, with cURus certified solenoids - see table E015 DHA-0= ex-proof (1)								Series number	Seals material: - = NBR PE = FKM BT = HNBR
Valve configuration: 61 - 63 - 71 Available spools: 0 - 0/2 - 1 - 1P - 1/2 - 1/2P - 3 - 3P - 4 - 7								Voltage code: see relevant tech. table	
Options, hand lever configuration: MO = horizontal hand lever (not for DHA) MV = vertical hand lever AMO = horizontal hand lever installed at the side of port B (not for DHA) AMV = vertical hand lever installed at the side of port B								Only for DHI and DHE: 00 = solenoids without coils, for DHI valve 00-AC = AC solenoids without coils, for DHE valve 00-DC = DC solenoids without coils, for DHE valve X = without connector	

(1) For DHA model code see table E120 (Multicertification) or E125 (UL)

2 MODEL CODE FOR PROPORTIONAL DIRECTIONAL VALVES AND FLOW CONTROL VALVES (for the details, see indicated tech.table)

DHZO	-	A	-	0	/	71	-	S5	/	MV	/*	**	/*
Directional proportional valves size 06 DHZO = see table F160 DHZE = see table F150 DHZA = ex-proof (1) Flow control valves size 06 QVHZO = see tab F410											Series number		Seals material: - = NBR PE = FKM BT = HNBR
A = without position transducer (2)											Coil option: see relevant tech. table		
Valve size 0 = ISO 4401 size 06 (for DHZ*) 06 = ISO 4401 size 06 (for QVHZO)											Options: MO = horizontal hand lever (not for DHA, DHZA) MV = vertical hand lever BMO = horizontal hand lever installed at the side of port A (not for DHZA, QVHZO) BMV = vertical hand lever installed at the side of port A (not for QVHZO) O = Horizontal cable entrance (only for DHZA) Y = External drain (only for DHZA, DHZO)		
Valve configuration (only DHZ*): 51, 53, 71, 73											Spool size (for DHZ*): S3 - S5 - D3 - D5 - L3 - L5 Max regulated flow (for QVHZO): 3-12-18-36-45 l/min		

(1) For DHZA model code see table F600 (Multicertification) or E125 (UL)

(2) Valves with position transducer (-T) and/or integrated electronics (only double solenoid valves -TE/-AE) available on request

3 LEVER CHARACTERISTICS

Total angle stroke	[°deg]	± 28°	Lever actuating force	[N]	1 ÷ 8
Working angle stroke	[°deg]	± 15°	Lever device weight	[g]	880

4 INSTALLATION DIMENSIONS [mm]

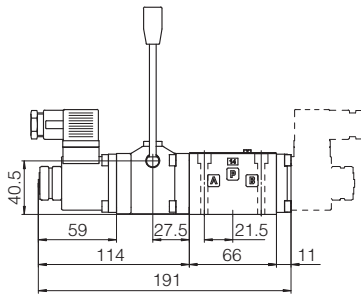

DHI-06*/MV Mass: 2,4 kg (single solenoid)
DHI-07*/MV (dotted line) Mass: 2,7 kg (double solenoid)

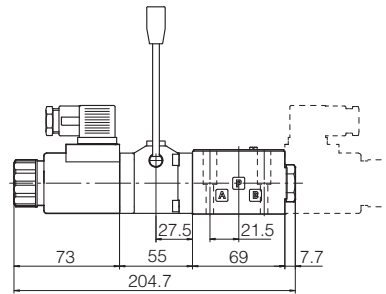
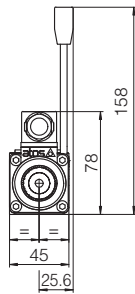

DHE-06*/MV Mass: 2,7 kg (single solenoid)
DHE-07*/MV (dotted line) Mass: 3,0 kg (double solenoid)

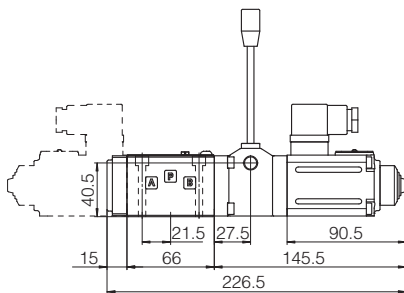
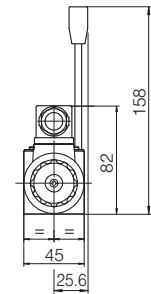

DHZO-A-05*/MV Mass: 2,8 kg (single solenoid)
DHZO-A-07*/MV (dotted line) Mass: 3,5 kg (double solenoid)

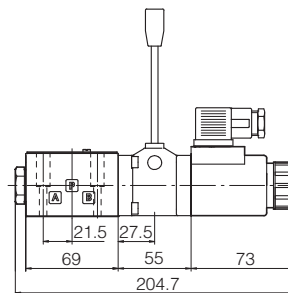
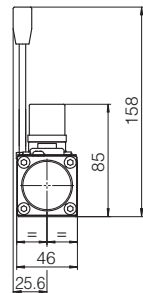

DHZE-05*/MV Mass: 2,7 kg (single solenoid)
DHZE-07*/MV (dotted line) Mass: 3,0 kg (double solenoid)

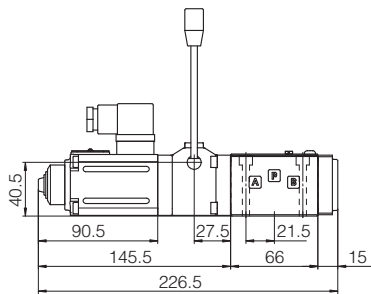
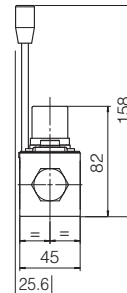

QVHZO-A-06*/MV Mass: 3,2 kg

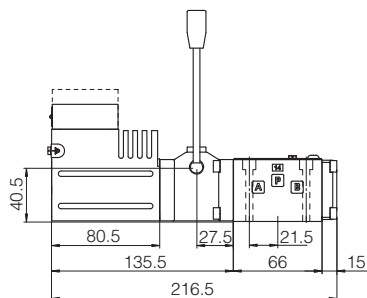
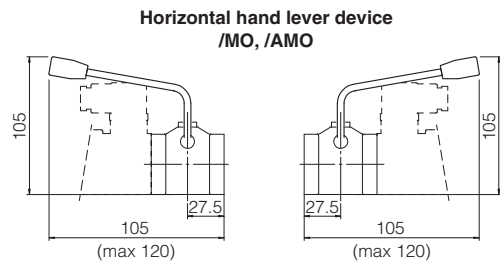
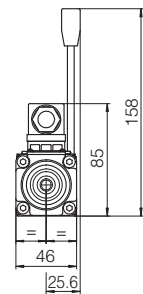

DHA/*-06*/MV
DHA/UL-*06*/MV (dotted line)

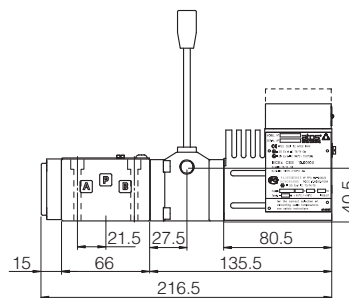
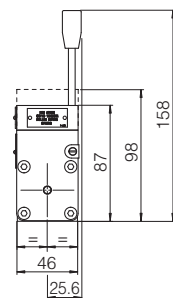

Mass: 3,4 kg

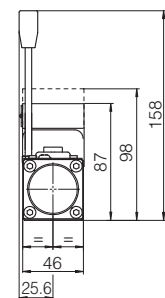

DHZA/*-06*/MV
DHZA/UL-*06*/MV (dotted line)